



Consumer Helpline

Australia

Phone: 1800 126 659
Fax: 1800 007 289

New Zealand

Phone: 0508 200 300
Fax: 0508 200 301

www.delonghi.com.au

www.delonghi.co.nz

Distributed by De'Longhi Australia Pty Ltd.
ABN 49 104 012 857
P.O. Box 4156 Milperra BC, NSW 1891

Distributed by De'Longhi New Zealand Ltd.
P.O. Box 58-056 Greenmount, Auckland

 is a registered Trademark
of De'Longhi Australia Pty Ltd.
ABN 49 104 012 857.

© 2013 De'Longhi Australia Pty Ltd.

De'Longhi Dishwasher

Model
DEDW650S



USER GUIDE

Please read this user guide carefully and retain for future reference

Parts and Features	03
De'Longhi Safety Precautions.	04
Dishwasher Safety Precautions	05
Installation Safety Precautions	07
Installation	08
- Positioning the Appliance	
- Levelling	
- AquaStop Anti-Flood Protection	
- Cold Water Connection	
- Drain Hose Connection	
Using your Dishwasher	10
- Quick start guide	
- Before Starting the Dishwasher	
- Prior to using for the first time	
- Rinse aid & detergent	
- Loading the Dishwasher Baskets	
- Starting a Washing Program	
- Control Panel	
- Turning on the Appliance	
- Change the Program	
- Forget to add a Dish?	
- At the end of the Wash Cycle	
Care and Cleaning.	22
- Filtering System	
- Filter Assembly	
- Cleaning the Filter	
- Caring for the Dishwasher	
- Protect against Freezing	
- Cleaning the Spray Arms	
- How to keep your Dishwasher in shape	
Troubleshooting	24
Error Codes	25
Help us Help You.	26
Warranty Information	27

The De'Longhi Dishwasher is warranted against faults resulting from manufacturing or material defects. The warranty period for normal domestic installation and use is two years from the date of purchase. In non-domestic use De'Longhi limits the voluntary warranty to 6 months.

De'Longhi undertakes to repair or replace the Dishwasher at our discretion if the product is found to be defective due to a manufacturing fault during the warranty period.

This warranty excludes any damage caused by misuse, neglect, shipping accident, or incorrect installation. Normal wear and tear is also expressly excluded. The warranty claim is void if no fault is found with the product or if work is carried out by anyone other than an authorised De'Longhi Service Agent.

In Australia, this warranty is additional to the conditions and guarantees which are mandatory as implied under the Trade Practices Act 1974 and State and Territory legislation.

How to contact us about a warranty claim

Talk to a De'Longhi representative for further warranty or product information please call the number in your country:

Australia
www.delonghi.com.au
Phone: 1800 126 659

New Zealand
www.delonghi.co.nz
Phone: 0508 200 300

NOTE: Warranty is determined by unit serial number and date of purchase.

Read this guide carefully, it is intended to help you operate and maintain your new Dishwasher properly.

Keep it handy to answer your questions. If you don't understand something or you need more assistance, please call the De'Longhi Helpline.

To help us provide prompt answers to your queries, please record your Dishwasher model and serial numbers. You'll find them on a plate located on the rear outside wall of the Dishwasher.

Dishwasher details

Date of Purchase

Model Number

Serial Number

Before you call for service

Check the Troubleshooting Section on page 24. It lists causes of minor operating problems that you can correct yourself.

STAPLE OR
AFFIX PURCHASE
RECIPT HERE

Model: DEDW650S

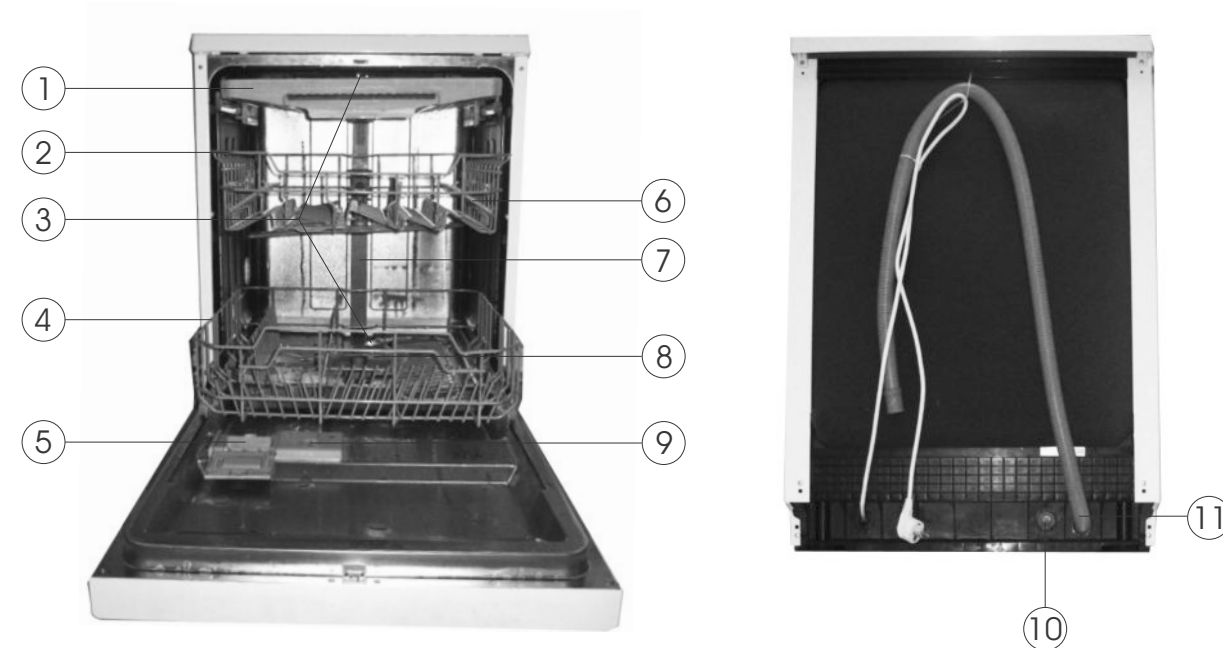

Components:

- | | |
|------------------------|--------------------------|
| 1. Cutlery Rack | 7. Inner Pipe |
| 2. Upper Basket | 8. Filter Assembly |
| 3. Spray Arms | 9. Rinse Aid Dispenser |
| 4. Lower Basket | 10. Inlet Pipe Connector |
| 5. Detergent Dispenser | 11. Drain Pipe |
| 6. Cup Shelf | |

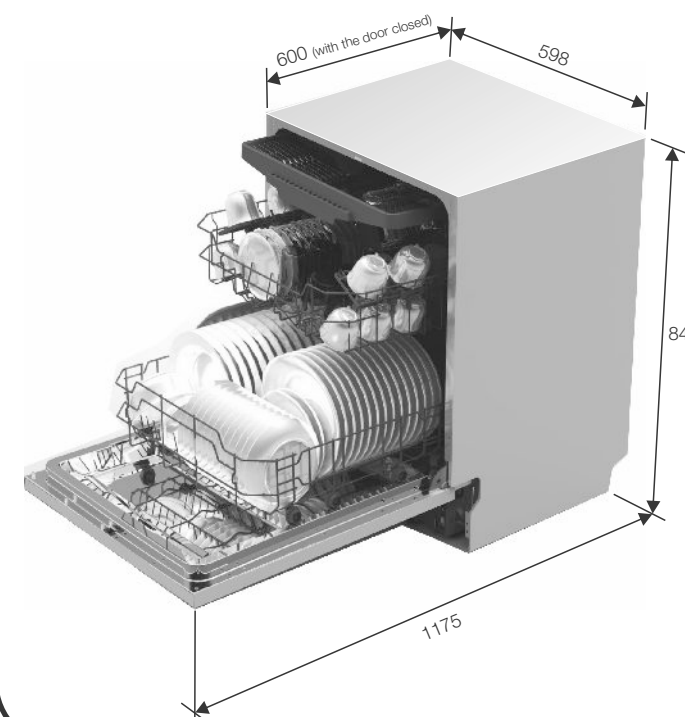

Dimensions:

- | | |
|--------|--------------------------|
| Height | 845mm |
| Width | 598mm |
| Depth | 600mm (with door closed) |

- | | |
|-------------------------|-------------------|
| Voltage connected Load: | see rating label |
| Water pressure: | 0.04-1.0MPa |
| Power supply: | see rating label |
| Capacity: | 15 place settings |

De'Longhi pride themselves on their innovative range of the highest quality consumer products.

De'Longhi ensures all of its products are 100% safe through quality design and manufacture. All products meet or exceed stringent laboratory-tested safety requirements.

It is necessary for anyone using an electrical appliance to be safety conscious. The following precautions are essential for the safe use of an electrical appliance. Carefully read all of the instructions provided with your appliance:

- Always turn the power off at the power outlet before you insert or remove a plug. Remove by grasping the plug, do not pull on the cord.
- Do not use your appliance with an extension cord unless this cord has been checked and tested by a qualified technician or service person. The extension cord must be a VDE-Listed, 3-wire grounding extension cord that has a grounding plug and outlet and that the electrical rating of the cord is 220-240 volts and at least 10 amperes.
- Always use your appliance from a power outlet of the voltage (A.C. only) marked on the appliance.
- Do not use an appliance for any purpose other than its intended use.
- Do not attempt to repair an electrical appliance. Return a damaged or malfunctioning appliance to a qualified service centre for adjustment or repair if required.
- The appliance must be positioned so the AC plug is accessible.

- This appliance is designed exclusively for household use. All other uses are strictly forbidden.
- The appliance is not intended for use by persons (including children) with reduced physical, sensory or mental capabilities, or lack of experience and knowledge, unless they have been given supervision or instruction concerning use of the appliance by a person responsible for their safety. Children should be supervised to ensure that they do not play with the appliance.
- If the power cable is damaged, it must be replaced by the manufacturer, an authorised service centre or a qualified electrician in order to eliminate all risk.
- This appliance is intended to be used in household and similar applications such as:
 - staff kitchen areas in shops, offices and other working environments;
 - farm houses;
 - by clients in hotels, motels and other residential type environments;
 - bed and breakfast type environments.

	Problem	Possible Causes	Solution
Unsatisfactory washing result	The dishes are not clean	The dishes were not loaded correctly.	See notes in " Loading the Dishwasher Baskets " .
		The program was not powerful enough.	Select a more intensive program. See " Wash Cycle Table " .
		Not enough detergent was dispensed.	Use more detergent, or change your detergent.
		Items are blocking the path of spray arms.	Rearrange the items so that the spray can rotate freely.
		The filter combination in the base of wash cabinet is not clean or is not correctly fitted. This may cause the spray arm jets to get blocked.	Clean and/or fit the filter combination correctly. Clean the spray arm jets. See "Cleaning the Spray Arms" .
Cloudiness on glassware	Combination of soft water and too much detergent.	Use less detergent if you have soft water and select a shortest cycle to wash the glassware and to get them clean.	
Black or gray marks on dishes	Aluminum utensils have rubbed against dishes.	Use a mild abrasive cleaner to eliminate those marks.	
Detergent left in dispenser cups	Dishes block detergent cups.	Re-loading the dishes properly.	
Unsatisfactory drying results	The dishes are not drying	Improper loading	Load the dishwasher as suggested in the directions.
		Too little rinse-aid	Increase the amount of rinse-aid/refill the rinse-aid dispenser.
		Dishes are removed too soon	Do not empty your dishwasher immediately after washing. Open the door slightly so that the steam can escape. Begin unloading the dishwasher only once the dishes are barely warm to the touch. Empty the low basket first. This prevents water from dropping off dishes in the upper basket.
		Wrong program has been selected	In short program the washing temperature is lower. This also lowers cleaning performance. Choose a program with a long washing time.
	Use of cutlery with a low-quality coating	Water drainage is more difficult with these items. Cutlery or dishes of this type are not suitable for washing in the dishwasher.	

ERROR CODES

When some malfunctions occur, the appliance will display error codes to warn you:

Codes	Meanings	Possible Causes
E1	Longer inlet time.	Faucets is not opened, or water intake is restricted, or water pressure is too low.
E4	Overflow	Some element of dishwasher leaks.
E8	Failure of orientation of distributary valve.	Open circuit or break of distributary valve.
EC	Fault of PCB data transmission.	PCB Failure

WARNING!

- If overflow occurs, turn off the main water supply before calling service.
- If there is water in the base pan because of an overflow or small leak, the water should be removed before restarting the dishwasher.

Before Calling for Service, review the following troubleshooting tips.

	<i>Problem</i>	<i>Possible Causes</i>	<i>Solution</i>
Technical problems	Dishwasher doesn't start	Fuse blown, or the circuit breaker acted	Replace fuse or reset circuit breaker. Remove any other appliances sharing the same circuit with the dishwasher
		Power supply is not turned on	Make sure the dishwasher is turned on and the door is closed securely. Make sure the power cord is properly plugged into the wall socket.
		Error code:E1; Water pressure is low	Check that the water supply is connected properly and the water is turned on.
		Door of dishwasher not properly closed.	Make sure to close the door properly and latch it.
Water not pumped from dishwasher	Water not pumped from dishwasher	Kink in drain hose	Check drain hose.
		Filter clogged	Check coarse the filter (see section titled "Cleaning The Filter ")
		Kitchen sink clogged	Check the kitchen sink to make sure it is draining well. If the problem is the kitchen sink not draining ,you may need a plumber rather than a serviceman for dishwashers.
General problems	Suds in the tub	Improper detergent	Use only the special dishwasher detergent to avoid suds. If this occurs, open the dishwasher and let suds evaporate. Add 3.75 litres of cold water to the tub. Close and latch the dishwasher, then select any cycle. Dishwasher will drain out the water at the first step. Open the door after the draining has stopped and check suds have disappeared. Repeat if necessary.
		Spilled rinse-aid	Always wipe up rinse-aid spills immediately.
	Stained tub interior	Detergent with colourant was used	Make sure that the detergent is the one without colourant.
	White film on inside surface	Hard water minerals	To clean the interior, use a damp sponge with dishwasher detergent and wear rubber gloves. Never use any other cleaner than dishwasher detergent for the risk of foaming or suds.
	There are rust stains on cutlery	The affected items are not corrosion resistant.	
A program was not run after dishwasher salt was added. Traces of salt have gotten into the wash cycle.		Always run the quick wash program without any crockery in the dishwasher and without selecting the Turbo function (if present), after adding dishwasher salt.	
Noise	Knocking noise in the wash cabinet	The lid of the softer is loose	Check the lip .Ensure the fix is fine.
		A spray arm is knocking against an item in a basket	Interrupt the program, and rearrange the items which are obstructing the spray arm.
	Rattling noise in the wash cabinet	Items of crockery are loose in the wash cabinet	Interrupt the program, and rearrange the items of crockery.
Knocking noise in the water pipes	This may be caused by on-site installation or the cross-section of the piping.	This has no influence on the dishwasher function. if in doubt, contact a suitably qualified plumber.	

IMPORTANT SAFETY INSTRUCTIONS - READ ALL INSTRUCTIONS BEFORE USING, AND SAVE FOR FUTURE REFERENCE.

Your safety and the safety of others is very important. Safety messages are displayed in this manual and on your appliance.

Read and obey these safety messages as they will alert you to potential hazards and tell you how to reduce the chance of injury.



Safety Alert Symbol

This symbol alerts you to potential hazards.

! DANGER !

Danger

Danger indicates a high level of risk to yourself and others. Ensure that care is taken to avoid severe injury or even death.

! WARNING !

Warning

Warning indicates a moderate level of risk to yourself, others and the product. Ensure that care is taken to avoid extensive product damage or serious injury.

CAUTION

Caution

Caution indicates a level of risk to yourself, others and the product. Ensure care is taken to avoid moderate product damage or injuries.



Before the appliance is used, it must be properly positioned and installed as described in this manual, so read the manual carefully. To reduce the risk of fire, electrical shock or injury when using the appliance, follow basic precaution, including the following:

⚠ DANGER ⚠

Grounding Instructions

- This appliance must be grounded. In the event of a malfunction or breakdown, grounding will reduce the risk of an electric shock by providing a path of least resistance of electric current. This appliance is equipped with a cord having an equipment-grounding conductor and a grounding plug. The plug must be plugged into an appropriate outlet that is installed and grounded in accordance with all local codes and ordinances.
- Improper connection of the equipment-grounding conductor can result in the risk of an electric shock.
- Check with a qualified electrician or service representative if you are in doubt whether the appliance is properly grounded. Do not modify the plug provided with the appliance; If it does not fit the outlet. Have a proper outlet installed by a qualified electrician.

⚠ WARNING ⚠

- Do not abuse, sit on, or stand on the door or dish rack of the dishwasher.
- Do not touch the heating element during or immediately after use. (This instruction is only applicable to machines with a visual heating element.)
- Do not operate your dishwasher unless all enclosure panels are properly in place. Open the door very carefully if the dishwasher is operating, there is a risk of water squirting out.
- Do not place any heavy objects on or stand on the door when it is open. The appliance could tip forward.
- When loading items to be washed:
 1. Locate sharp items so that they are not likely to damage the door seal;
 2. Warning: Knives and other utensils with sharp points must be loaded in the basket with their points down or placed in a horizontal position.
- Check that the detergent compartment is empty after completion of the wash cycle.

⚠ WARNING ⚠

- When using your dishwasher, you should prevent plastic items from coming into contact with the heating element (This instruction is only applicable to machines with a visual heating element).
- Do not wash plastic items unless they are marked dishwasher safe or the equivalent. For plastic items not so marked, check the manufacturer's recommendations.
- Use only detergent and rinse additives designed for an automatic dishwasher.
- Never use soap, laundry detergent, or hand washing detergent in your dishwasher. Keep these products out of the reach of children.
- Keep children away from detergent and rinse aid, keep children away from the open door of the dishwasher, there could still be some detergent left inside.
- This appliance is not intended for use by persons (including children) with reduced physical, sensory or mental capabilities, or lack of experience and knowledge, unless they have been given supervision or instruction concerning use of the appliance by a person responsible for their safety.
- Children should be supervised to ensure that they do not play with the appliance.
- Dishwasher detergents are strongly alkaline, they can be extremely dangerous if swallowed. Avoid contact with skin and eyes and keep children away from the dishwasher when the door is open.
- The door should not be left open, since this could increase the risk of tripping.
- If the supply cord is damaged, it must be replaced by the manufacturer or its service agent or a similarly qualified person in order to avoid a hazard.
- Remove the door to the washing compartment when removing an old dishwasher from service or discarding it.
- Please dispose of packing materials properly.
- Use the dishwasher only for its intended function.
- During installation, the power supply must not be excessively or dangerously bent or flattened.
- Do not tamper with controls.
- The appliance is to be connected to the water mains using new hose sets and that old hose-sets should not be reused.
- The maximum number of place settings to be washed is 15.
- The maximum permissible inlet water pressure is 1Mpa.
- The minimum permissible inlet water pressure is 0.04Mpa.

Caring for the Dishwasher

The control panel can be cleaned by using a lightly dampened cloth. After cleaning, make sure to dry it thoroughly.

For the exterior, use a good appliance polish wax.

Never use sharp objects, scouring pads or harsh cleaners on any part of the dishwasher.

Cleaning the Door

To clean the edge around the door, you should use only a soft warm, damp cloth.

To avoid penetration of water into the door lock and electrical components, do not use a spray cleaner of any kind.

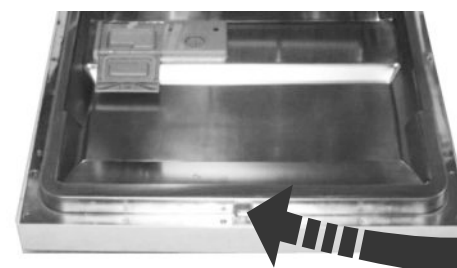

WARNING!

- Never use a spray cleaner to clean the door panel as it may damage the door lock and electrical components.
- Abrasive agents or some paper towels should not be used because of the risk of scratching or leaving spots on the stainless steel surface.

Protect against Freezing

Please take frost protection measures on the dishwasher in winter. After washing cycles, please operate as follows:

1. Turn off the electrical power to the dishwasher.
2. Turn off the water supply and disconnect the water inlet pipe from the water valve.
3. Drain the water from the inlet pipe and water valve. (Use a pan to catch the water)
4. Reconnect the water inlet pipe to the water valve.
5. Remove the filter at the bottom of the tub and use a sponge to soak up water in the sump.

NOTE: If your dishwasher cannot work because of the ice, please contact an authorised service person.

Cleaning the Spray Arms

It is necessary to clean the spray arms regularly for hard water chemicals will clog the spray arm jets and bearings.

To remove the upper spray arm, hold the nut and rotate the arm clockwise to remove it.

To remove the lower spray arm, pull out the spray arm upward.

Wash the arms in soapy and warm water and use a soft brush to clean the jets. Replace them after rinsing them thoroughly.

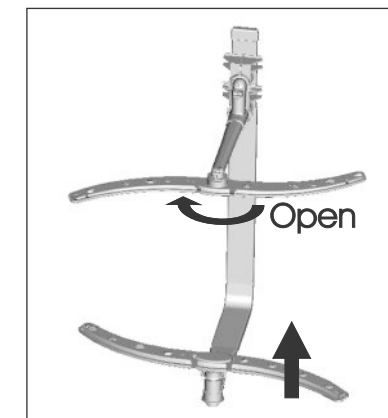

How to keep your Dishwasher in shape

- After every wash, turn off the water supply to the appliance and leave the door slightly open so that moisture and odours are not trapped inside.
- Before cleaning or performing maintenance, always remove the electrical plug from the socket.
- To clean the exterior and rubber parts of the dishwasher, do not use solvents or abrasive cleaning products. Only use a cloth with warm soapy water.
- To remove spots or stains from the surface of the interior, use a cloth dampened with water and a little vinegar, or a cleaning product made specifically for dishwashers.

When not in Use for a long time

It is recommended that you run a wash cycle with the dishwasher empty and then remove the plug from the socket, turn off the water supply and leave the door of the appliance slightly open. This will help the door seals to last longer and prevent odours from forming within the appliance.

Moving the Appliance

If the appliance must be moved, try to keep it in the vertical position. If absolutely necessary, it can be positioned on its back.

Seals

One of the factors that cause odours to form in the dishwasher is food that remains trapped in the seals. Periodic cleaning with a damp sponge will prevent this from occurring.

Filtering System

The filter prevents larger remnants of food or other objects from getting inside the pump.

The residue may block the filter, in this case they must be removed.

The filter system consists of a coarse filter, a flat (Main filter) and a microfilter (Fine filter).

- ① **MAIN FILTER:** Food and soil particles trapped in this filter are pulverized by a special jet on the lower spray arm and washed down the drain.
- ② **COARSE FILTER:** Larger items, such as pieces of bones or glass, that could clog the drain are trapped in the coarse filter. To remove an item caught in this filter, gently squeeze the taps on the top of this filter and lift it out.
- ③ **FINE FILTER:** This filter holds soil and food residues in the sump area and prevents it from being redeposit on the dishes during a cycle.

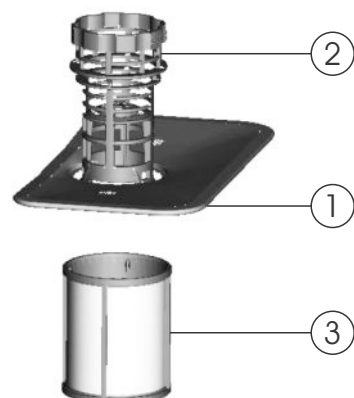

Filter Assembly

The filter efficiently removes food particles from the wash water, allowing it to be recycled during the cycle.

For best performance and results, the filter must be cleaned regularly. For this reason, it is a good idea to remove the larger food particles trapped in the filter after each wash cycle by rinsing the semicircular filter and cup under running water.

To remove the filter device, pull the cup handle in the upward direction.

WARNING!

- The dishwasher must never be used without the filters.
- Improper replacement of the filter may reduce the performance level of the appliance and damage dishes and utensils.

STEP 1: Turn the filter in anti-clockwise direction.



STEP 2: Lift the filter assembly up.



NOTES:

- When following this procedure from step 1 to step 2, the filter system will be removed; when following it from Step 2 to Step 1, the filter system will be installed.
- Inspect the filters for blocking after every time the dishwasher has been used.
- By unscrewing the coarse filter, you can remove the filter system. Remove any food remnants and clean the filters under running water.
- The entire filter assembly should be cleaned once a week.

Cleaning the Filter

To clean the coarse filter and the fine filter, use a cleaning brush. Reassemble the filter parts as shown in the figures on the last page and reinsert the entire assembly in the dishwasher, positioning it in its seat and pressing downwards.

WARNING!

- When cleaning the filters, do not knock on them. Otherwise, the filters could be contorted and the performance of the dishwasher could be decreased.

Electrical Connection

- This appliance should be properly grounded for your safety. The power cord of this appliance is equipped with a three-prong plug which mates with standard three prong wall outlets to minimise the possibility of electrical shock.
- DO NOT UNDER ANY CIRCUMSTANCES CUT OR REMOVE THE EARTHING CONNECTION FROM THE POWER CORD SUPPLIED. FOR PERSONAL SAFETY, THIS APPLIANCE MUST BE PROPERLY GROUNDED.
- Please look at the rating label to know the rating voltage and connect the dishwasher to the appropriate power supply. Use the required fuse 10 amp, time delay fuse or circuit breaker recommended and provide separate circuit serving only this appliance.
- Ensure the voltage and frequency of the power being used corresponds to those on the rating plate. Only insert the plug into an electrical socket which is earthed properly. If the electrical socket to which the appliance must be connected is not appropriate for the plug, replace the socket, rather than using a adapters or the like as they could cause overheating and burns.
- The cord should be secured behind the appliance and not left exposed or dangling to prevent accidental injury.
- The appliance should always be plugged into its own individual electrical outlet which has a voltage rating that matches the rating label on the appliance. This provides the best performance and also prevent overloading house wiring circuits that could cause a fire hazard from overheated. Never unplug the appliance by pulling the power cord. Always grip the plug firmly and pull straight out from the receptacle. Repair or replace immediately all power cords that have become frayed or otherwise damaged. Do not use a cord that shows cracks or abrasion damage along its length or at either end. When moving the appliance, be careful not to damage the power cord.

Extension Cord

- **WARNING: DO NOT USE AN EXTENSION CORD OR AN ADAPTER PLUG WITH THIS APPLIANCE.**

Grounding Instructions

- This appliance must be earthed. In the event of a malfunction or breakdown, earthing will reduce the risk of electric shock by providing a path of least resistance for the electric current. This appliance is equipped with a cord having an equipment-earthing conductor and an earthing plug. The plug must be plugged into an appropriate outlet that is installed and earthed in accordance with all local standards and requirements.

WARNING

- Improper connection of the equipment earthing conductor can result in the risk of an electric shock.
- Check with a qualified electrician or service representative if you are in doubt whether the appliance is properly earthed.
- Do not modify the plug provided with the appliance. If the plug does not fit properly to the outlet, please have a qualified electrician install a proper outlet.

Positioning the Appliance

- Position the appliance in the desired location. The back should rest against the wall behind it, and the sides, along the adjacent cabinets or walls. The dishwasher is equipped with water supply and drain hoses that can be positioned either to the right or the left sides to facilitate proper installation.

Levelling

- Once the appliance is positioned for levelling, the height of the dishwasher may be altered via adjustment of the screwing level of the feet. In any case, the appliance should not be inclined more than 2°.

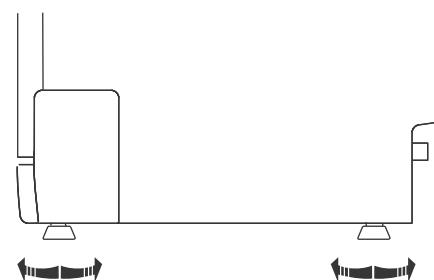

AquaStop Anti-Flood Protection

- Your dishwasher is fitted with an AquaStop anti-flood protection system. This system consists of a solenoid safety shut off valve which in the unlikely event of a leak, a float switch will signal the Solenoid to cut off the water supply. Therefore avoiding any flooding.
- Do not immerse the water inlet hose or the safety valve in water. There is an electrical cable for the safety valve in the double-walled water inlet hose.
- If water inlet hose or the safety valve is damaged, remove the main plug immediately.
- Do not enlarge or shorten the inlet hose because it contains electric parts.



Cold Water Connection

How to Connect the safety supply hose

The appliance must be connected to the water mains using new hose-sets. The old hose-sets should not be reused.

Water pressure must be between 0.04 MPa and 1 MPa. If the pressure is below the minimum, consult our Service Department for advice.

If the water pipes are new or have not been used for an extended period of time, let the water run to make sure that the water is clear. This precaution is needed to avoid the risk of the water inlet getting blocked and damaging the appliance.

- Pull the safety supply hose completely out from the storage compartment located at the rear of dishwasher.
- Connect the cold water supply hose to a threaded 3/4(inch) connector and make sure that it is fastened tightly in place.
- Turn water fully on before starting the dishwasher.

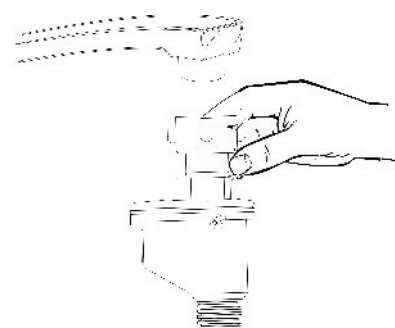

WARNING! In order to avoid water staying in the inlet hose, please close the hydrant after using.

WARNING! A hose that attaches to a sink spray can burst if it is installed on the same water line as the dishwasher. If your sink has one, it is recommended that the hose be disconnected and the hole plugged.

How to disconnect the safety supply hose

- Turn off the water.
- Unscrew the safety supply hose from the faucet.

TURNING ON THE APPLIANCE

Starting a wash cycle:

- Draw out the lower and upper basket, load the dishes and push them back. It is recommended to load the lower basket first, then the upper one (see the section entitled "Loading the Dishwasher").
- Pour in the detergent (see Page 14).
- Insert the plug into the socket. The power supply is 220-240 VAC /50 HZ, the specification of the socket is 10A 250VAC. Make sure that the water supply is turned on to full pressure.
- Close the door, press the ON/OFF button to switch on the machine.
- Press the program button to select your desired program, when the program is selected, the response icon will light, then press the Start/Pause button, the dishwasher begins to start.

NOTE: When you press the Start/Pause button to pause during washing, the running indicator will stop blinking and the dishwasher will sound every minute unless you press the Start/Pause button to start.

CHANGE THE PROGRAM

Premise:

- A cycle that is underway can only be modified if it has only been running for a short time. Otherwise, the detergent may have already been released, and the appliance may have already drained the wash water.
If this is the case, the detergent dispenser must be refilled (see the section entitled "Adding Detergent").
- Press the Start/Pause button, the machine will be in standby mode, then press the program button more than 3 seconds then you can change the program to the desired cycle setting (see the section entitled "Starting a wash cycle. . .").

NOTE: If you open the door during a wash cycle, the machine will pause. The program light will stop blinking and the buzzer will sound every minute until you close the door. After you close the door, the machine will keep on working after 10 seconds.

FORGET TO ADD A DISH?

A forgotten dish can be added at any time before the detergent cup opens.

- Press the Start/Pause button.
- Open the door a little to stop the washing.
- After the spray arms stop working, you can open the door completely.
- Load the forgotten dishes.
- Close the door.
- Press the Start/Pause button, the dishwasher will start running again after 10 seconds.

WARNING! It is dangerous to open the door when washing, because the hot water may scald you.

AT THE END OF THE WASH CYCLE

When the working cycle has finished, the buzzer of the dishwasher will sound for 8 seconds, then stop. Turn off the appliance using the Power switch button, shut off the water supply and open the door of the dishwasher to avoid handling the dishes and utensils while they are still hot and more susceptible to breakage. They will also dry better.

Switch off the Dishwasher

The program light is on but is not blinking, only in this case the programme has ended.

- Switch off the dishwasher by pressing Power button.
- Turn off the water tap!

Open the door carefully

Hot dishes are sensitive to knocks. The dishes should be allowed to cool down around 15 minutes before removing from the appliance.

Open the dishwasher's door, leave it ajar and wait a few minutes before removing the dishes. Dishes will be cooler and the drying will be improved.

Unloading the Dishwasher

It is normal that the dishwasher is wet inside.

Empty the lower basket first and then the upper one. This will avoid water dripping from the upper Basket onto the dishes in the lower one.

CONTROL PANEL

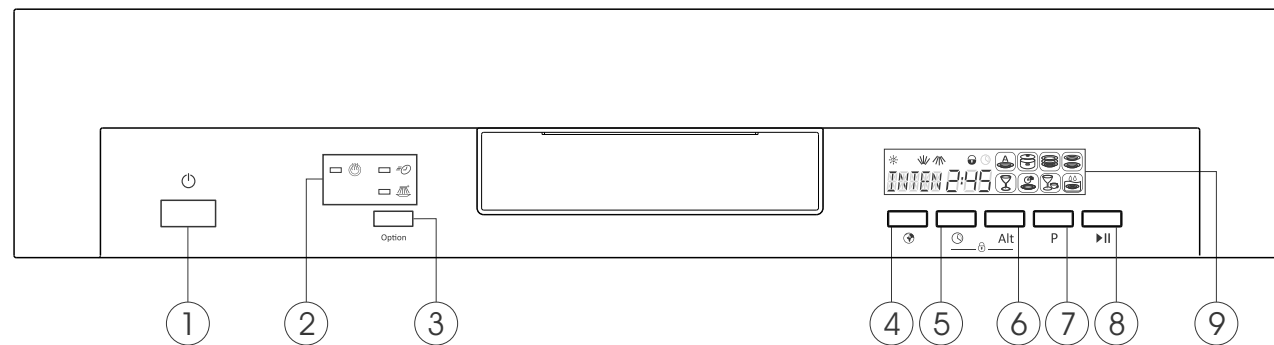

- ① **Power button:** To turn on/off the power supply.
- ② **Option function indicator:**
Extra Drying ☀ Express ⚡ Strong Wash 🍽
- ③ **Option button:** Press the button to select option functions in the following direction.
Extra Drying, Express, Strong Wash

Extra drying - An increased temperature during the final rinse to increase drying well. There is a slight increase in the energy consumption. (This function can only be used with programmes Intensive, Heavy, Normal, Glass and 1 Hour).

Express - This function can reduce the running time, water and energy consumption are slight increased. (This function can only be used with programmes Intensive, Heavy, Normal and Glass).

Strong Wash - This function can wash very soiled pots and pans. The temperature and water is increased during the washing cycle. (This function can only be used with programmes Intensive, Heavy, Normal, Glass and 1 Hour).

- ④ **Language Button:** Press the button to select the appropriate language. English, French, German, Russian, Italian, Dutch

- ⑤ **Delay Button:** Press to delay the wash.
- ⑥ **Alt Button:** Dual zone wash function, press the button to select either upper basket or lower basket loaded and the response indicators will light up.
- ⑦ **Program button:** Press the button to select appropriate program.
- ⑧ **Start /Pause button:** To start the selected washing program or pause the washing program when the machine is working.
- ⑨ **Display screen:** to show the remaining time and the state(running state, delay time,error codes etc)

- Rinse Aid indicator: *
Indicates when the dispenser needs to be refilled.
- Alt functions indicator: 🍽 🍽
- Child lock indicator: 🔒
- Delay function indicator: ⌚
- Program indicators: 🍽 🍽 🍽 🍽 🍽 🍽 🍽 🍽
- Language indicator: 🇬🇧 🇫🇷 🇩🇪 🇷🇺 🇮🇹 🇳🇱
- Delay time ,Remain time ,or error codes indicator: 8:88

Attention:
Child lock function: press two buttons(🔒 + Alt) simultaneously to lock the program.

Drain Hose Connection

- Insert the drain hose into a drain pipe with a minimum diameter of 40mm, or let it run into the sink, making sure to avoid bending or crimping it. The top of the hose must be at a height less than 1000mm. The free end of the hose must not be immersed in water to avoid back flow.

Syphon Connection

- Insert the drain hose into a drain pipe with a minimum diameter of 40mm, or let it run into the sink, making sure to avoid bending or crimping it. The top of the hose must be less than 1000mm.

How to Drain Excess Water from Hoses

- If the sink is more than 100cm higher than the floor, the excess water in the hose cannot be drained directly into the sink. It will be necessary to drain excess water from the hose into a bowl or suitable container that is held outside and lower than the sink.

Water Outlet

- Connect the water drain hose. The drain hose must be correctly fitted to avoid water leaks. Ensure that the water drain hose is not kinked or squashed.

Extension Hose

- If you need a drain hose extension, make sure to use a similar drain hose.
- It must be no longer than 4 metres; otherwise the cleaning effect of the dishwasher could be reduced.

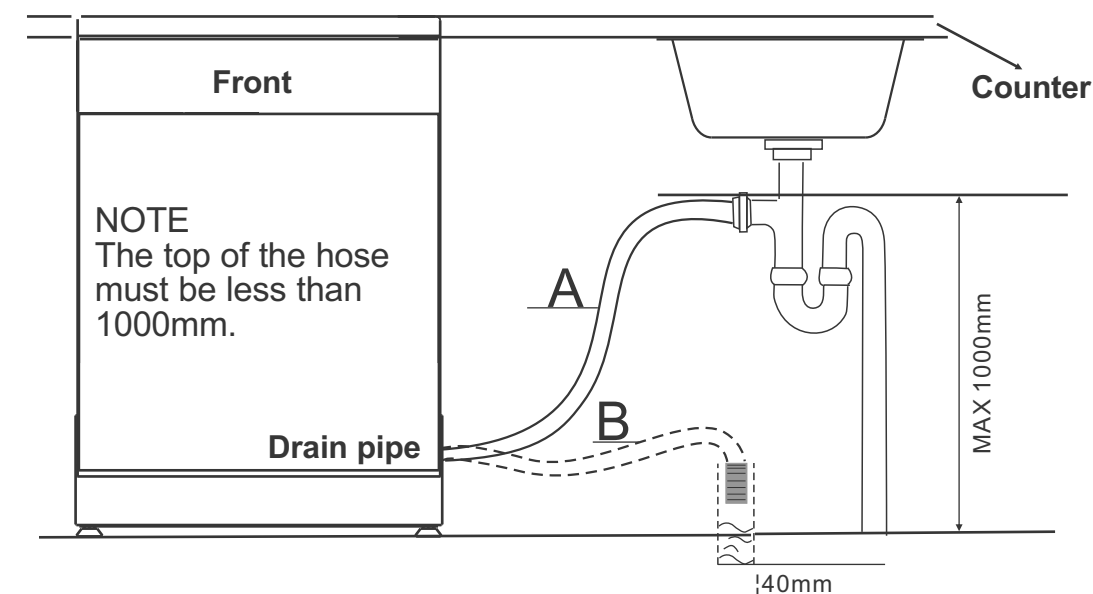

Using Your Dishwasher

QUICK START GUIDE

For detailed operating method read the corresponding content on the instruction manual.

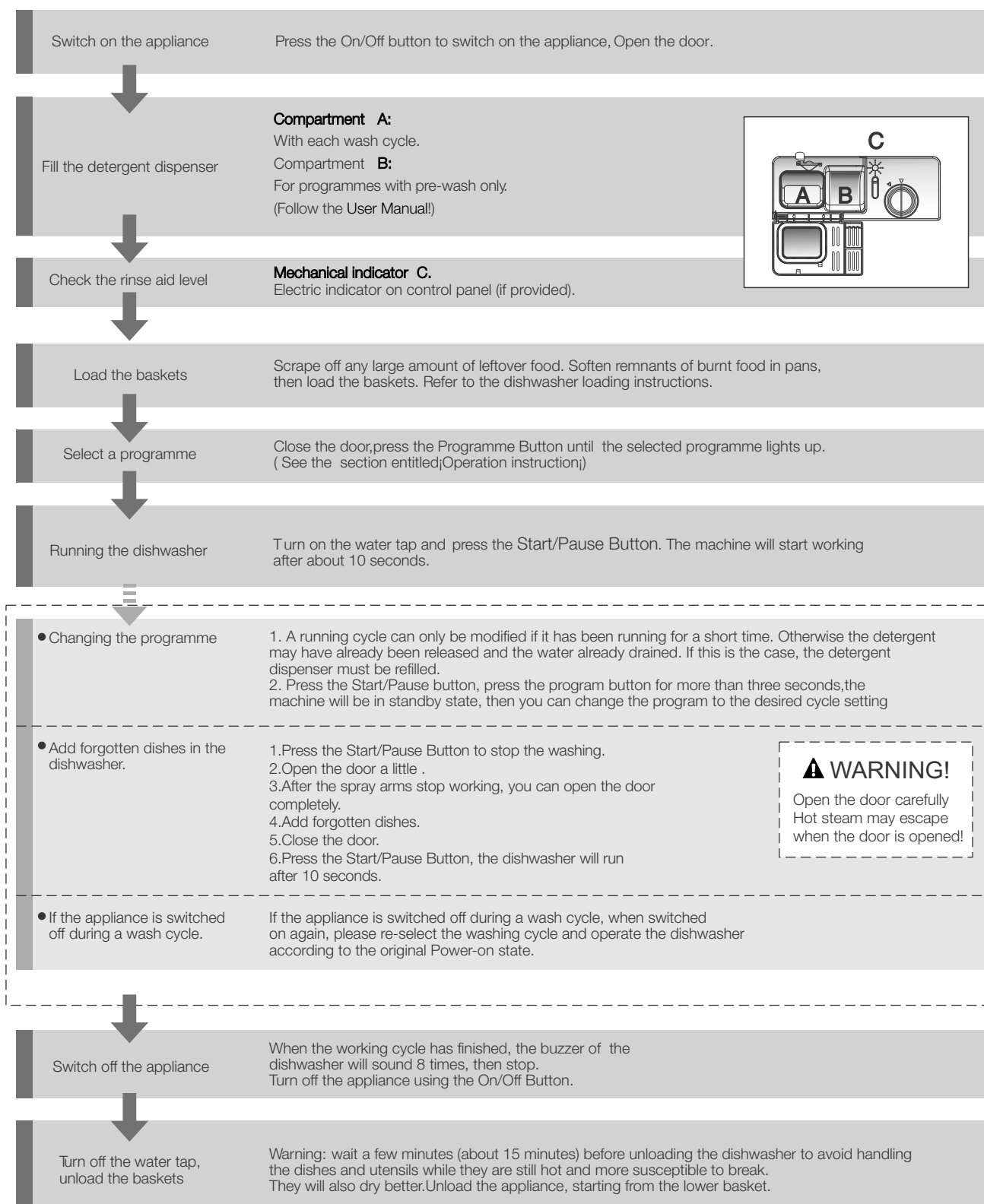

Using Your Dishwasher

STARTING A WASHING PROGRAM

Wash Cycle Table

NOTE: Star (★) means the need to fill rinse aid into the Rinse Aid Dispenser.

Program	Cycle Selection Information	Description of Cycle	Detergent pre/main	Running time(min)	Energy (Kwh)	Water (L)	Rinse Aid
Auto 	Auto sensing wash, lightly, commonly or heavily soiled crockery, with or without dried-on food	Pre-wash (45 °C) Autowash(50-60 °C) Rinse Rinse (60 °C) Drying	5/28.75g (Or All in 1)	120~170	1.1~1.4	10.0~13.5	★
Intensive 	For heaviest soiled crockery, and soiled pots, pans, dishes etc with dried on soiling.	Pre-wash(50°C) Wash (65°C) Rinse Rinse(65°C) Drying	5/28.75g (Or All in 1)	155	1.45	17.0	★
Heavy 	For heavily soiled loads, such as pots, plates, glasses and lightly soiled pans.	Pre-wash(45°C) Wash (55°C) Rinse Rinse (60°C) Drying	5/28.75g (Or All in 1)	170	1.15	13.5	★
Normal <small>(*AS/NZS 2007.1)</small> 	Standard daily cycle for normally soiled loads, such as pots, plates, glasses.	Pre-wash Wash (50 °C) Rinse Rinse(50°C) Drying	5/28.75g (Or All in 1)	170	0.80	12.0	★
Glass 	For lightly soiled crockery and glass.	Pre-wash Wash (40 °C) Rinse Rinse(60°C) Drying	5/28.75g	115	0.85	13.5	★
1 Hour 	For lightly soiled loads that do not need excellent drying efficiency.	Pre-wash(50°C) Wash(60°C) Rinse (50°C) Drying	5/28.75g	60	0.80	9.0	★
Rapid 	A shorter wash for lightly soiled loads that do not need drying.	Wash (40 °C) Rinse Rinse (45 °C)	20g	40	0.50	10.0	
Soak 	To rinse dishes that you plan to wash later that day.	Pre-wash		8	0.01	3.8	

NOTE:

*AS/NZS 2007.1: This program is the test cycle.

The information for comparability test in accordance with AS/NZS 2007.1, as follows:

- Capacity: 15 setting
- Position Upper basket: Upper wheels on rails
- Rinse aid setting: 6
- Open the door slightly 50mm to assist in drying of the dishes after every wash





Cutlery Basket

Cutlery should be placed in the cutlery rack separately from each other in the appropriate positions shown below. Make sure the utensils do not nest together, this may cause bad performance.

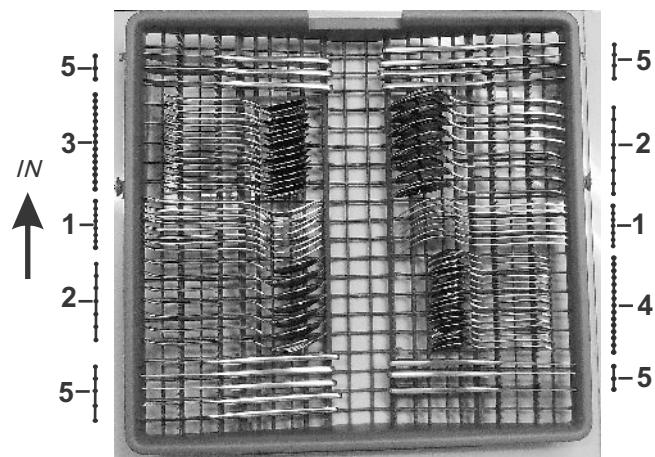
For a top quality clean, place the silverware in the basket making sure that:

- They do not nest together.
- Silverware is placed with the male face up.
- Long utensils in the middle.



1	Forks	
2	Soup spoons	
3	Dessert spoons	
4	Teaspoons	
5	Knives	

Damage to glassware and other dishes

Possible Causes

- Type of glass or manufacturing process. Chemical composition of detergent.
- Water temperature and duration of dishwasher program.

Suggested remedy:

- Use glassware or porcelain dishes that have been marked dishwasher-proof by the manufacturer
- Use a mild detergent that is described as kind of dishes. If necessary, seek further information from detergent manufacturers.
- Select a program with as low a temperature.
- To prevent damage, take glass and cutlery out of the dishwasher as soon as possible after the program has ended, as possible after the program has ended.

BEFORE STARTING THE DISHWASHER

The following things should be checked before starting the dishwasher:

1. That the dishwasher is level and fixed properly.
2. That the inlet valve is open.
3. There is no leakage at the connections of the conducts.
4. The wires are tightly connected.
5. The power is switched on.
6. The inlet and drain hoses are not knotted or kinked.
7. All packing & print materials should be taken out of the dishwasher.

PRIOR TO USING FOR THE FIRST TIME

Before using your dishwasher for the first time:

Fill the Rinse Aid Dispenser

The rinse aid is released during the final rinse to prevent water from forming droplets on your dishes, which can leave spots and streaks. It also improves drying by allowing water to roll off the dishes. Your dishwasher is designed to use liquid rinse aids. The rinse aid dispenser is located inside the door next to the detergent dispenser. To fill the dispenser, open the cap and pour the rinse aid into the dispenser until the level indicator turns completely black. The volume of the rinse aid container is about 110ml.

Function of the Rinse Aid

Rinse aid is automatically added during the last rinse, ensuring thorough rinsing, and spot and streak free drying.

WARNING!

Only use branded rinse aid for dishwashers. Never fill the rinse aid dispenser with any other substances (e.g. Dishwasher cleaning agent, liquid detergent). This would damage the appliance.

When to refill the Rinse Aid Dispenser

If there is no rinse-aid warning light in the control panel, you can judge the amount of rinse-aid by the colour of the optical level indicator "C" located next to the cap. When the rinse-aid container is full, the whole indicator will be dark. As the rinse-aid diminishes, the size of the dark dot decreases. You should never let the rinse aid get below 1/4 full.

As the rinse aid diminishes, the size of the black dot on the rinse aid level indicator changes, as illustrated below.

- Full
- 3/4 Full
- 1/2 Full
- 1/4 Full (Should refill to eliminate spotting)
- Empty

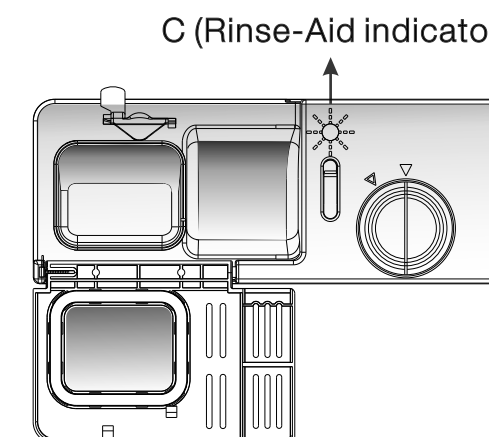

Using Your Dishwasher

How to fill the Rinse Aid Dispenser

1. To open the dispenser, turn the cap to the "open" (left) arrow and lift it out.
2. Pour the rinse aid into the dispenser, being careful not to overfill.
3. Replace the cap by inserting it aligned with "open" arrow and turning it to the closed (right) arrow.

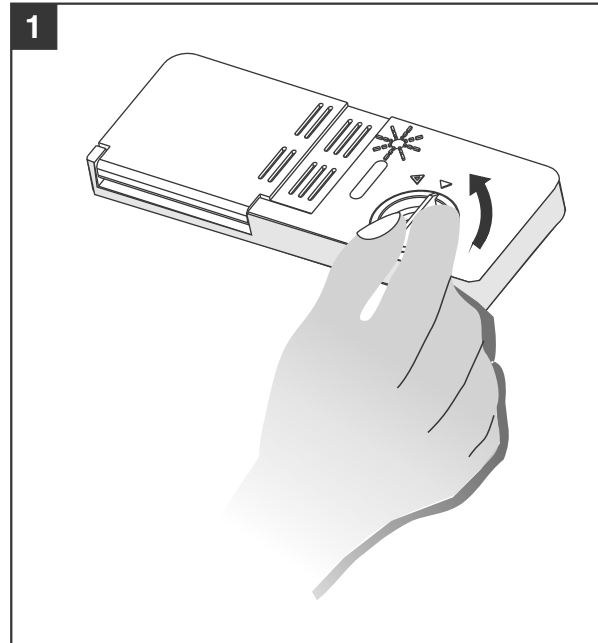

Be careful not to overfill the dispenser, because this could cause over sudsing. Wipe away any spills with a damp cloth. Don't forget to replace the cap before you close dishwasher door.

ATTENTION! Clean up any rinse aid spilt during filling with an absorbent cloth to avoid excess foaming during the next wash.

Using Your Dishwasher

Loading the Lower Basket

We suggest that you place large items and the most difficult to clean items are to be placed into the lower basket: such as pots, pans, lids, serving dishes and bowls, as shown in the figure below.

It is preferable to place serving dishes and lids on the side of the racks in order to avoid blocking the rotation of the top spray arm.

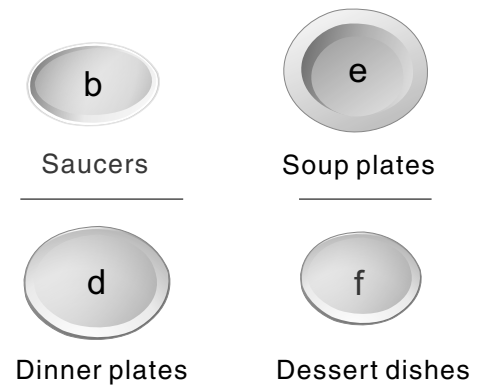
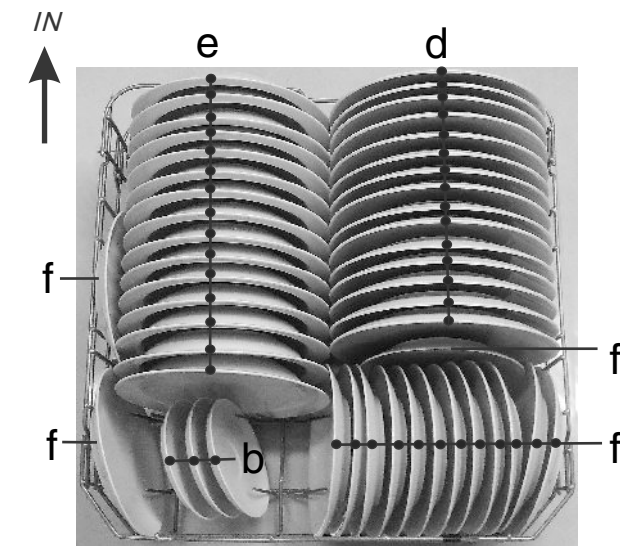

Folding spikes of Lower Basket

For better stacking of pots and pans, the spikes can be folded down as show in the picture below.



Loading the Upper Basket

The upper basket is designed to hold more delicate and lighter dishware such as glasses, coffee and tea cup and saucers, as well as plates, small bowls and shallow pans (as long as they are not too dirty).

Position the dishes and cookware so that they do not get moved by the spray of water.

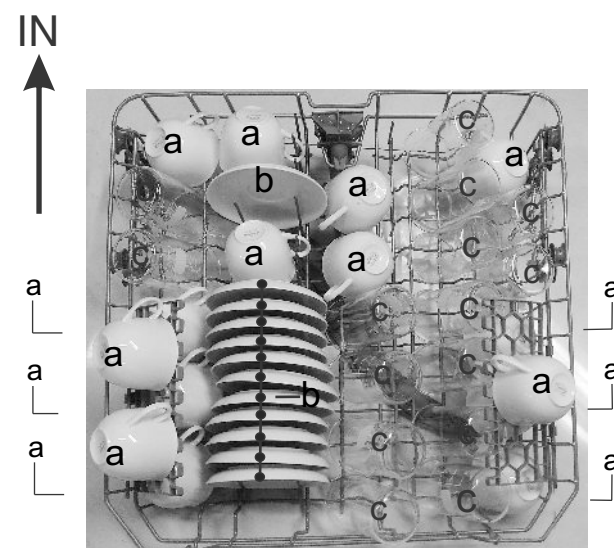

Cups

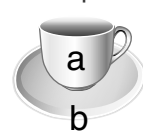

Saucers



Glasses

Please be reminded that:

- Pots, serving bowls, etc, must always be placed top down.
- Deep pots should be slanted to allow water to flow out.
- The Bottom Basket features folding spikes so that larger or more pots and pans can be loaded.

Adjusting the Upper Basket

The height of the upper basket can be adjusted in order to create more space for large utensils both for the upper/lower basket. The height of the upper basket can be adjusted by lifting the handle on either side of the basket, see pictures below:

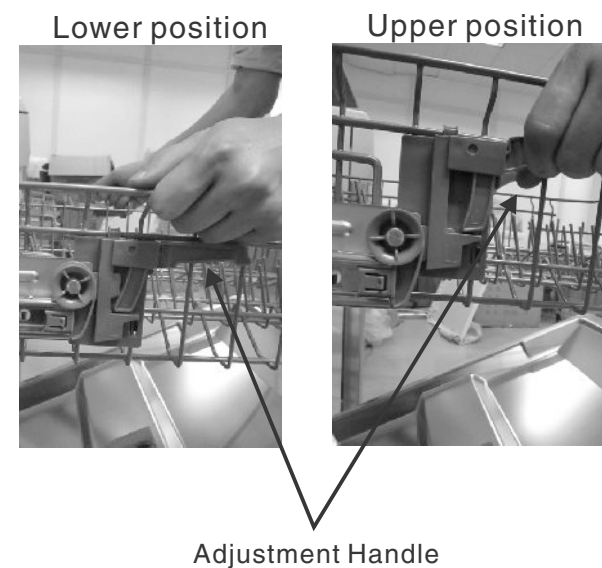

Folding back the cup shelves

For reduced loads, the additional cup shelves can be folded down if not required as shown below.

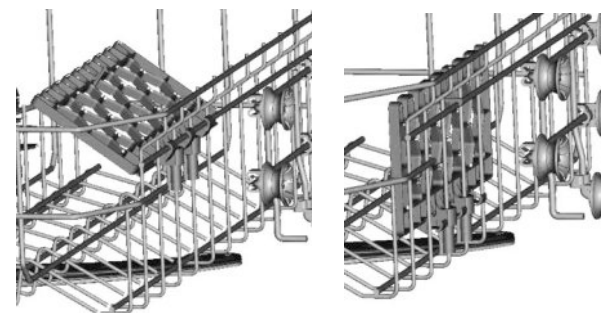

Adjusting the Rinse Aid Dispenser

The rinse aid dispenser has six or four settings. Always start with the dispenser set on "4". If spots and poor drying are a problem, increase the amount of rinse aid dispensed by removing the dispenser lid and rotating the dial to "5". If the dishes are still not drying properly or show spots, adjust the dial to the next higher level until your dishes are spot free. The recommended setting is "4". (Factory value is "4".)

NOTE: Increase the dose if there are drops of water or lime spots on the dishes after washing. Reduce it if there are sticky whitish stains on your dishes or a bluish film on glassware or knife blades.

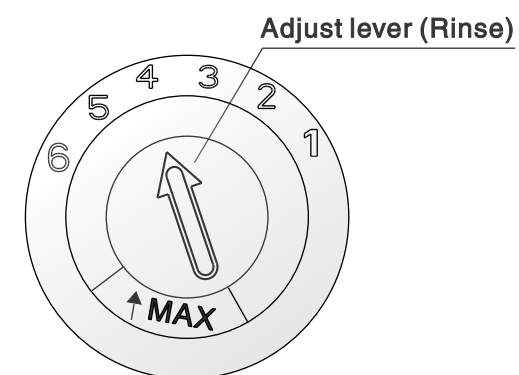

Detergents

Detergents have chemical ingredients that are necessary to remove dirt, crush dirt and transport it out of the dishwasher. Most of the commercial quality detergents are suitable for this purpose.

There are 3 sorts of detergents:

1. With phosphate and with chlorine
2. With phosphate and without chlorine
3. Without phosphate and without chlorine

Normally new pulverised detergent is without phosphate. Thus the water softener function of phosphate is not given. In this case we recommend to fill salt in the salt container even when the hardness of water is only 6 °dH. If detergents without phosphate are used in the case of hard water often white spots appear on dishes and glasses. In this case please add more detergent to reach better results. Detergents without chlorine do only bleach a little. Strong and coloured spots will not be removed completely. In this case please choose a program with a higher temperature.

Concentrated Detergent

Based on their chemical composition, detergents can be split in two basic types:

- Conventional, alkaline detergents with caustic components
- Low alkaline concentrated detergents with natural enzymes

The use of "normal" washing programs in combination with concentrated detergents reduces pollution and is good for your dishes; these wash programs are specifically matched to the dirt-dissolving properties of the enzymes of the concentrated detergent. For this reason "normal" wash programs in which concentrated detergents are used can achieve the same results that can otherwise only be achieved using "intensive" programs.

Detergent Tablets

Detergent tablets of different brands dissolve at different speeds. For this reason some detergent tablets cannot dissolve and develop their full cleaning power during short programs. Therefore please use long programs when using detergent tablets, to ensure the complete removal of detergent residuals.

Detergent Dispenser

The dispenser must be refilled before the start of each wash cycle following the instructions provided in the wash cycle table. Your dishwasher uses less detergent and rinse aid than Conventional dishwasher. Generally, only one tablespoon of detergent is needed for a normal wash load. More heavily soiled items need more detergent. Always add the detergent just before starting the dishwasher, otherwise it could get damp and will not dissolve properly.

Adding detergent to Dishwasher

- If the lid is closed: press release button. The lid will spring open.
- Always add the detergent just before starting each wash cycle.
- Only use branded detergent aid for dishwasher.

Detergent Dispenser

The dispenser must be refilled before the start of each wash cycle following the instructions provided in the wash cycle table. Your dishwasher uses less detergent and rinse aid than Conventional dishwasher. Generally, only one tablespoon of detergent is needed for a normal wash load. More heavily soiled items need more detergent. Always add the detergent just before starting the dishwasher, otherwise it could get damp and will not dissolve properly.

Adding detergent to Dishwasher

- If the lid is closed: press release button. The lid will spring open.
- Always add the detergent just before starting each wash cycle.
- Only use branded detergent aid for dishwasher.

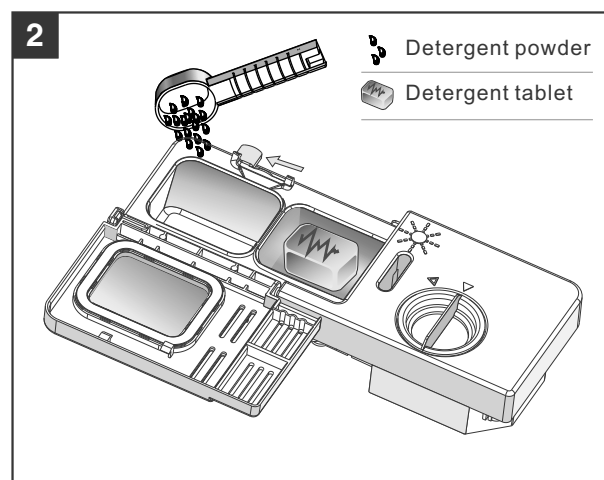
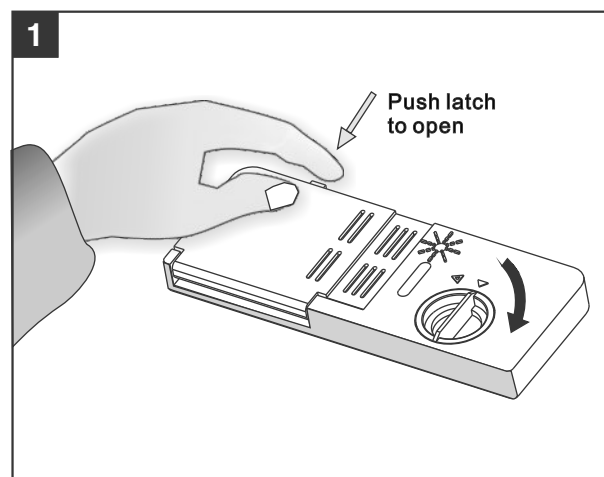

WARNING! Dishwasher detergent is poisonous! Take care to keep it out of reach of children.

Proper Use of Detergent

- Only use detergent specifically made for the use in dishwashers. Keep your detergent fresh and dry.
- Don't put powdered detergent into the dispenser until you're ready to wash dishes.

Fill the detergent dispenser with detergent. The marking indicates the dosing levels, as shown below:

- (A) Location of main wash cycle detergent.
- (B) Location of pre-wash cycle detergent.

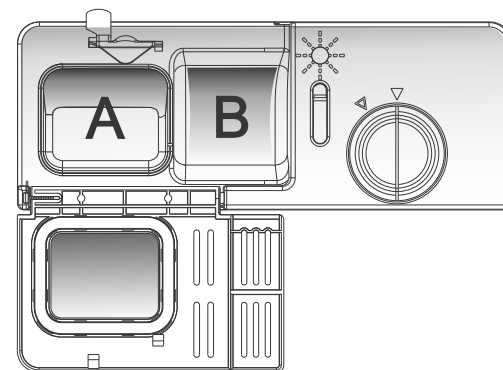

Please observe the manufacturers dosing and storage recommendations as stated on the detergent packaging.

Close the lid and press until it locks in place.

If the dishes are heavily soiled, place an additional detergent dose in the pre-wash detergent chamber. This detergent will take effect during the pre-wash phase.

NOTE: See information about the amount of detergent for the single programs on page 19. Please be aware, that according to the level soiling and the specific hardness of water differences are possible.

Please observe the manufacturer's recommendations on the detergent packaging.

LOADING THE DISHWASHER BASKET

Recommendation

- Consider buying utensils which are identified as dishwasher-proof.
- Use a mild detergent that is described as 'kind to dishes'. If necessary, seek further information from the detergent manufacturers.
- For particular items, select a program with as low a temperature as possible.
- To prevent damage, do not take glass and cutlery out of the dishwasher immediately after the programme has ended.

Suitability of use in the dishwasher

NOT SUITABLE FOR USE

- Cutlery with wooden, horn china or mother-of-pearl handles
- Plastic items that are not heat resistant
- Older cutlery with glued parts that are not temperature resistant
- Bonded cutlery items or dishes
- Pewter or cooper items
- Crystal glass
- Steel items subject to rusting
- Wooden platters
- Items made from synthetic fibres

LIMITED SUITABILITY

- Some types of glasses can become dull after a large number of washes
- Silver and aluminum parts have a tendency to discolour during washing
- Glazed patterns may fade if machine washed frequently

Attention before or after Loading the Dishwasher Baskets.

For best performance of the dishwasher, follow these loading guidelines. Features and appearance of baskets and cutlery baskets may vary from your model.

Scrape off any large food particles. Soften remnants of burnt food in pans.

It is not necessary to rinse the dishes under running water. Place objects in the dishwasher in following way:

1. Items such as cups, glasses, pots/pans, etc. are faced downwards.
2. Curved items, or ones with recesses, should be loaded aslant so that water can run off.
3. All utensils are stacked securely and can not tip over.
4. All utensils are placed in the way that the spray arms can rotate freely during washing.

NOTE: Very small items should not be washed in the dishwasher as they could easily fall out of the baskets.

- Load hollow items such as cups, glasses, pans etc. With the opening facing downwards so that water cannot collect in the container or a deep base.
- Dishes and items of cutlery must not lie inside one another, or cover each other.
- To avoid damage to glasses, they must not touch.
- Load large items which are most difficult to clean into the lower basket.
- The upper basket is designed to hold more delicate and lighter dishware such as glasses, coffee and tea cups
- Long bladed knives stored in an upright position are a potential hazard!
- Long and/or sharp items of cutlery such as carving knives must be positioned horizontally in the upper basket.
- Please do not overload your dishwasher. This is important for good results and for reasonable consumption of energy.

Removing the Dishes

To prevent water dripping from the upper basket into the lower basket, we recommend that you empty the lower basket first and then the upper basket.